



STEEL STAR
www.greatforming.com



Más de 15 años de experiencia en máquinas perfiladoras



Planes claros Precios claros



Haga el mejor plan para usted

Máquina formadora de rollos

Cangzhou Steelstar Machinery Co.,Ltd.

Contenido



Perfil de la empresa



Socios extranjeros



Exposiciones



STEEL STAR
www.greatforming.com

Contenido



Catalogo de producto

1. Máquina formadora de rollos de láminas de techo
2. Máquina formadora de rieles para pernos de quilla ligera
3. Máquina formadora de rollos de puerta de persiana
4. Máquina perfiladora de correas C/Z
5. Máquina formadora de rollos de tapa de cresta
6. Máquina formadora de rollos corrugados de barril
7. Máquina formadora de rollos de cubierta de piso
8. Máquina perfiladora de tableros de automóviles
9. Máquina perfiladora de canalones de lluvia/bajantes



STEEL STAR
www.greatforming.com



Catalogo de producto

Contenido

10. Máquina formadora de rollos de marco de villa de quilla ligera
11. Máquina perfiladora de placas de barandilla
12. Línea de producción de compuestos de láminas para techos de espuma/lana de roca
13. Máquina desbobinadora/apiladora automática de láminas para paneles de techo
14. Máquina dobladora / Cizalla guillotina
15. Línea de corte longitudinal de bobinas de acero
16. Máquina de soporte solar
17. Máquina para fabricar tubos de acero
18. Se pueden personalizar varios productos

Contenido



Envío al extranjero



Servicio



Contacta con nosotros



STEEL STAR
www.greatforming.com

Perfil de la empresa

La fábrica tiene una superficie de 20000m².

Fábrica de producción real.

Servicio en línea las 24 horas.

15 años de experiencia en la industria

Cooperado con más de 30 países.



Planes claros Precios claros

Software de diseño de copra alemán.



Tiene muchos socios extranjeros.

Obtuvo múltiples certificaciones internacionales.



STEEL STAR
www.greatforming.com

Vista de fábrica de la empresa

Área de fabrica



Taller de mecanizado de materias primas



Taller de producción de ensamblaje





STEEL STAR
www.greatforming.com

Certificado de honor de la empresa





STEEL STAR
www.greatforming.com

Socios extranjeros





STEEL STAR
www.greatforming.com

Exposiciones

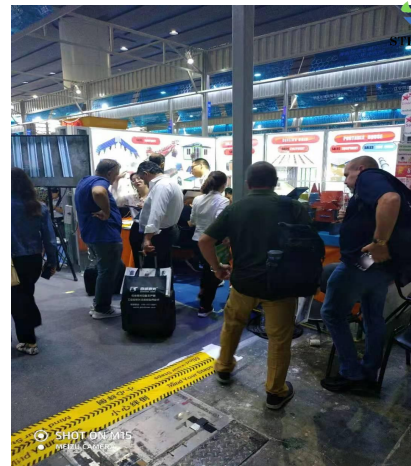
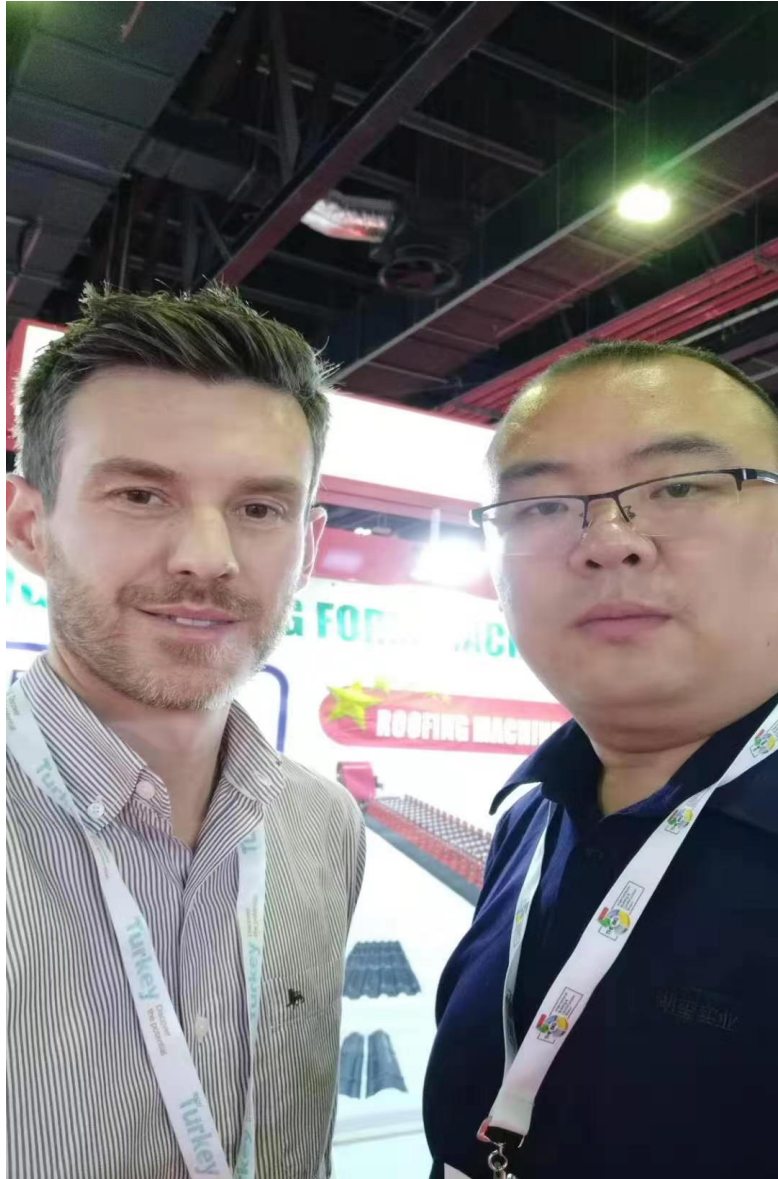



STEEL STAR
www.greatforming.com

Catalogo de producto

1. Máquina formadora de rollos de láminas de techo

1-1 Máquina formadora de rollos de láminas de techo trapezoidales de un solo modelo

Escenarios de aplicación





STEEL STAR
www.greatforming.com

Catalogo de producto

1-1 Máquina formadora de rollos de láminas de techo trapezoidales de un solo modelo

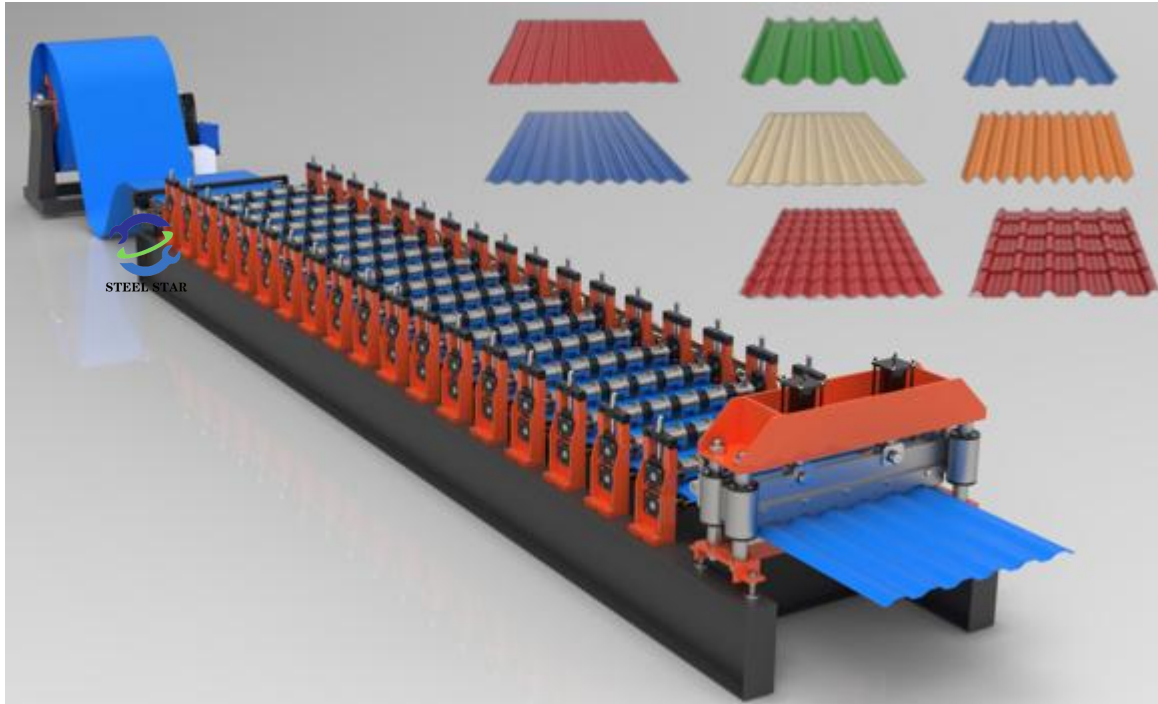

1. Máquina formadora de rollos de láminas de techo

Trapezoidal roofing sheet

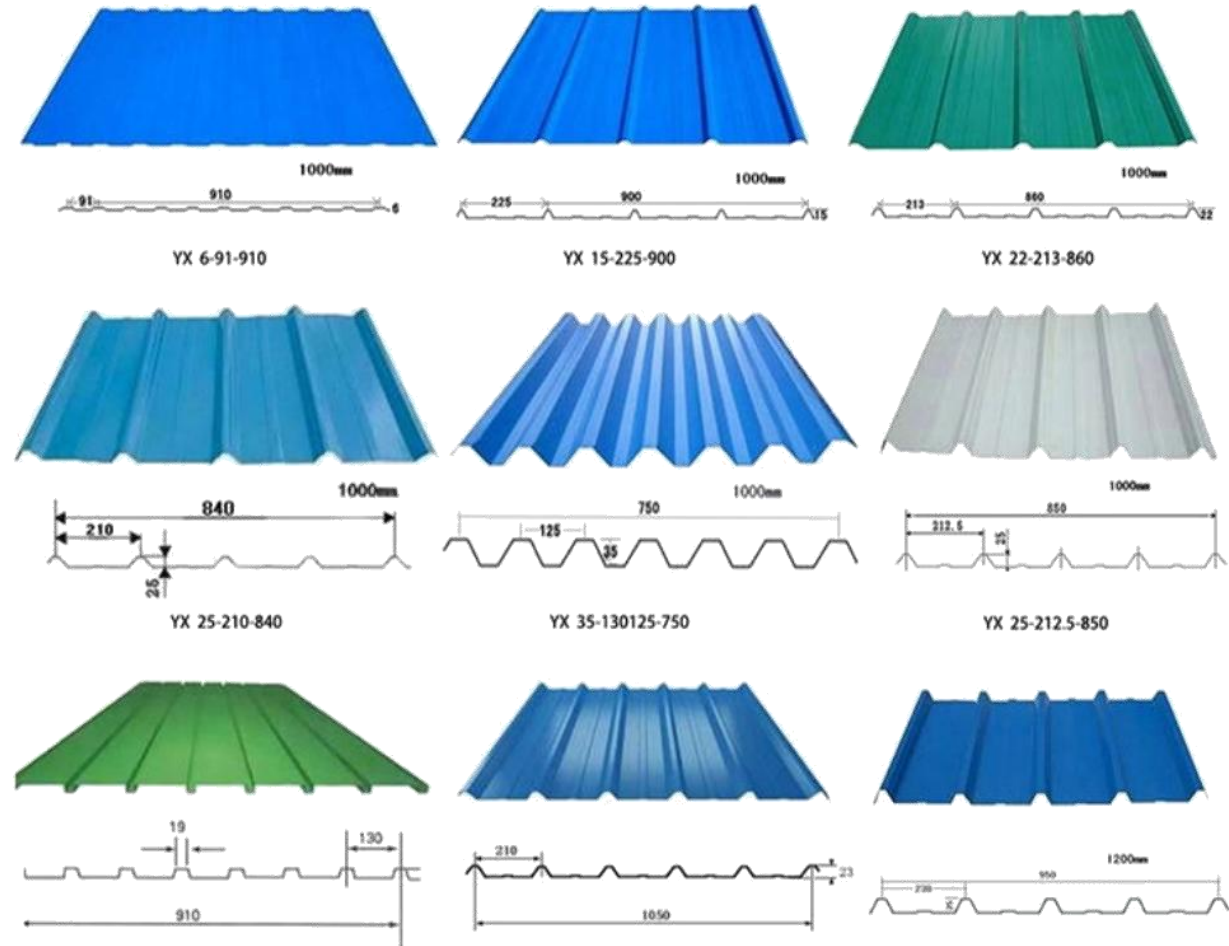



STEEL STAR
www.greatforming.com

Catalogo de producto

1. Máquina formadora de rollos de láminas de techo

1-2 Máquina perfiladora de láminas de techo corrugado de un solo modelo

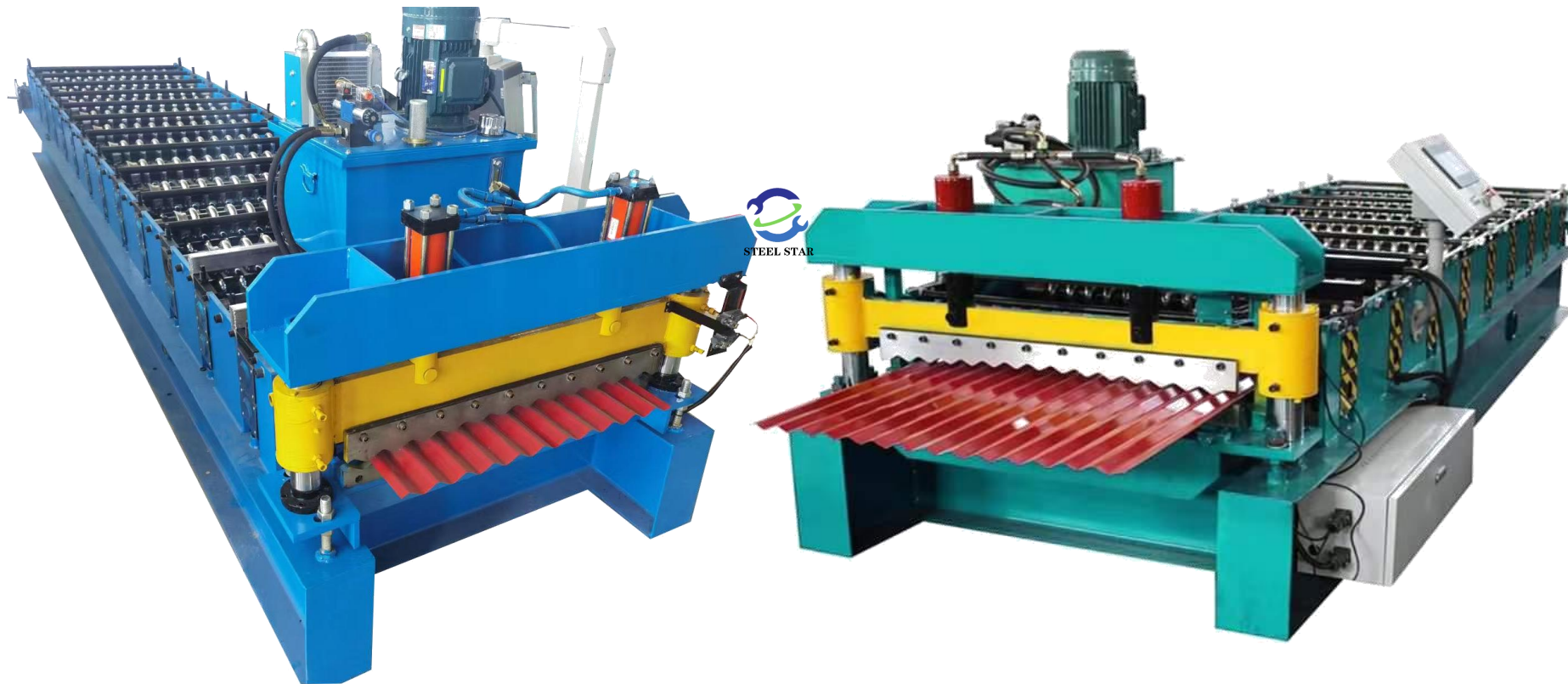

Escenarios de aplicación





STEEL STAR
www.greatforming.com

Catalogo de producto

1. Máquina formadora de rollos de láminas de techo

1-2 Máquina perfiladora de láminas de techo corrugado de un solo modelo

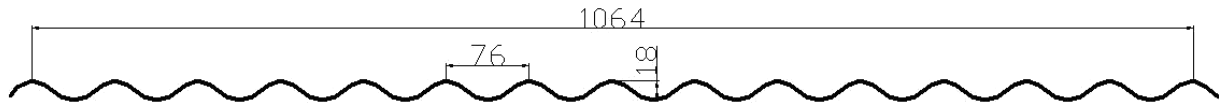

进料宽度: 1250mm

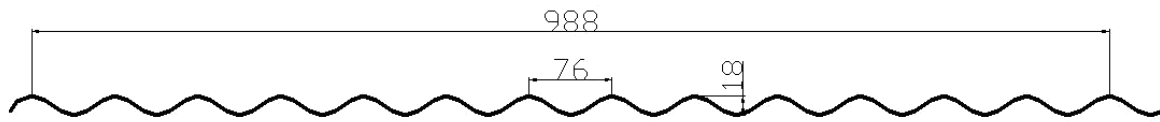

进料宽度: 1200mm

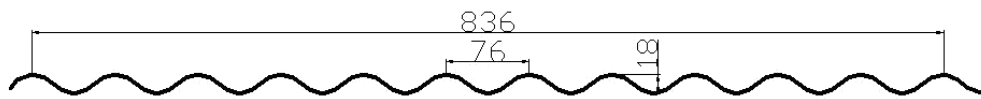

进料宽度: 1000mm

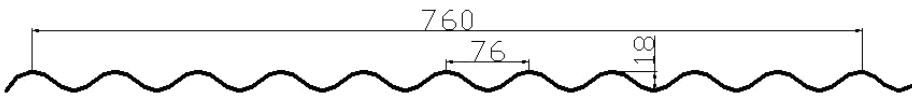

进料宽度: 940mm

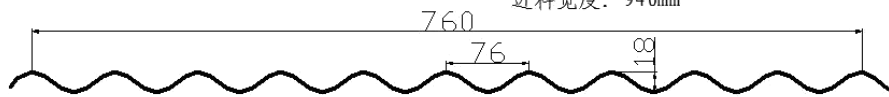

进料宽度: 914mm

Wave roofing sheet

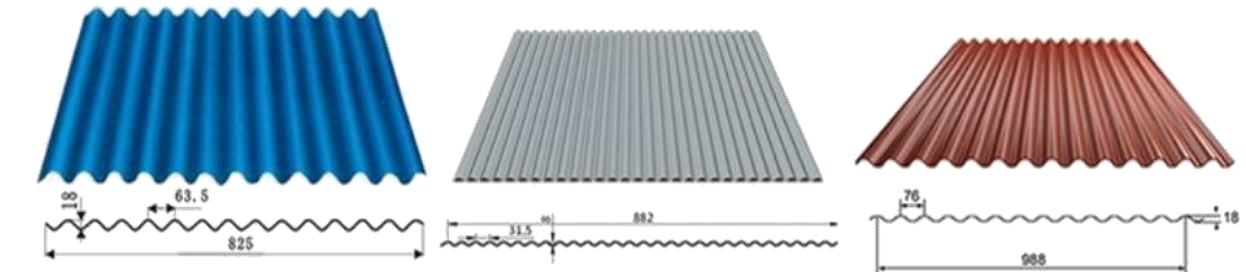

YX 18-63.5-825

YX 8-31.5-882

YX 18-76-988

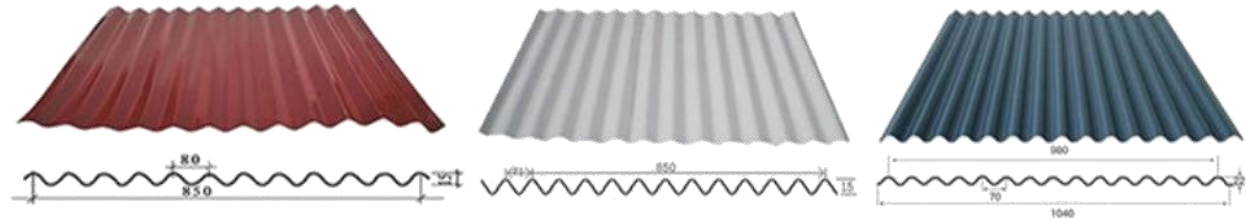

YX 15-80-850

YX 15-71-850

YX 22-70-980

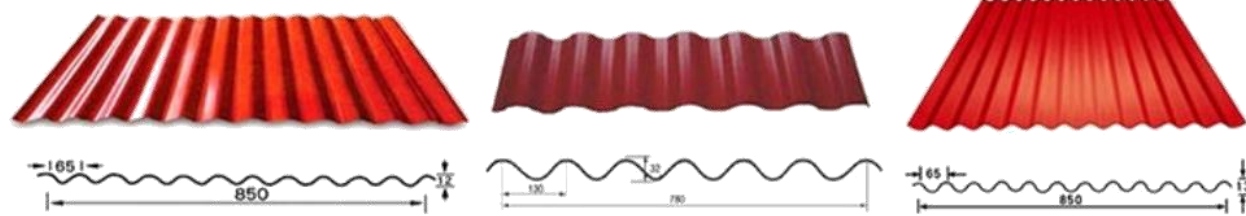

YX 12-65-850

YS 32-130-780

YS 13-65-850



STEEL STAR
www.greatforming.com

Catalogo de producto

1. Máquina formadora de rollos de láminas de techo

1-3 Máquina formadora de rollos de láminas de techo de tejas esmaltadas de un solo modelo

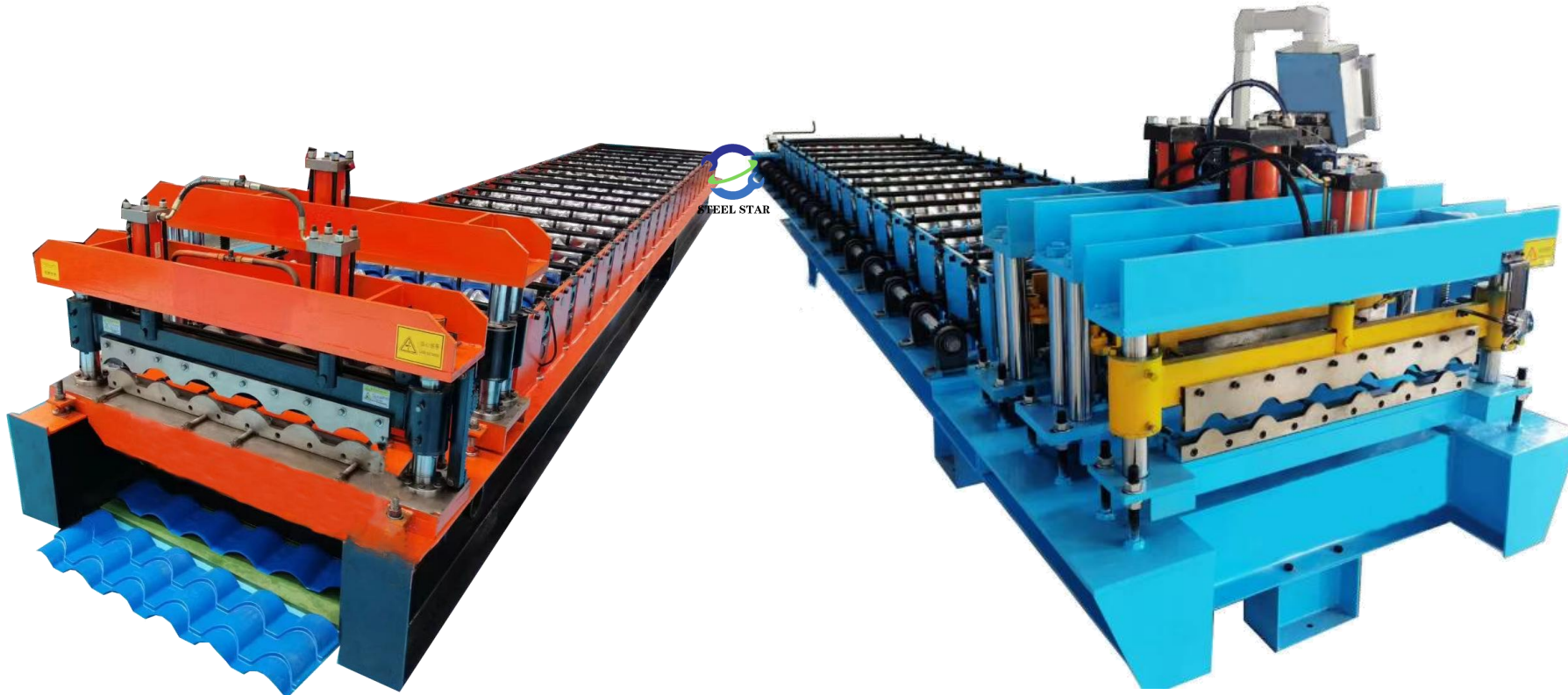

Escenarios de aplicación





STEEL STAR
www.greatforming.com

Catalogo de producto

1. Máquina formadora de rollos de láminas de techo

1-3 Máquina formadora de rollos de láminas de techo de tejas esmaltadas de un solo modelo



Glazed roofing sheet

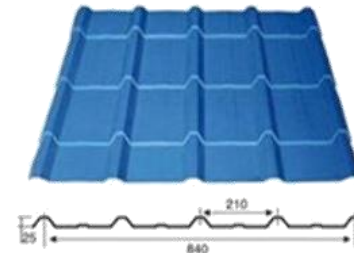

YX 25-210-840

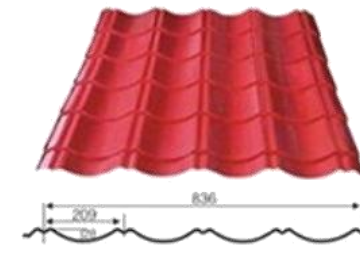

YX 28-29-836

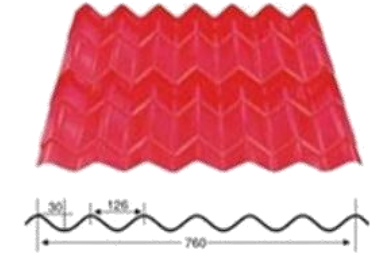

YX 30-126-760

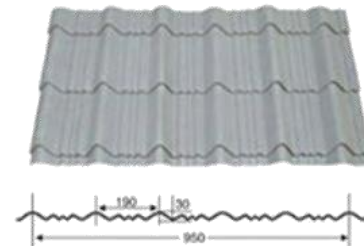

YX 30-190-950

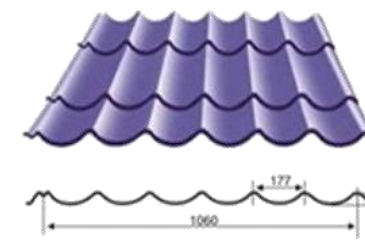

YX 30-177-1060

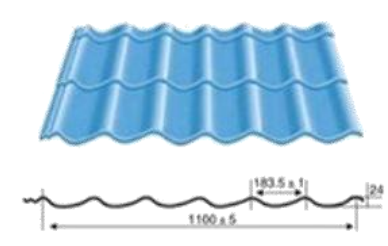

YX 24-183.5-1100

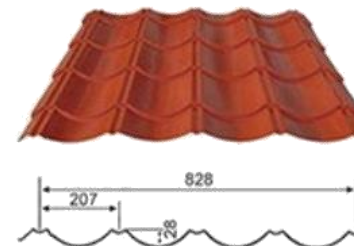

YX 28-207-828

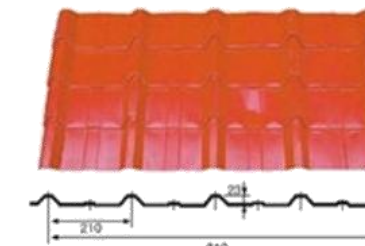

YX 28-207-828

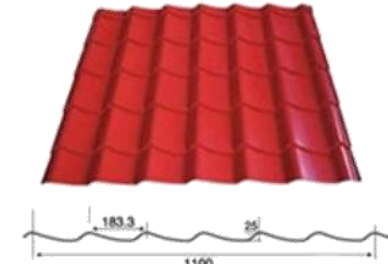

YX 25-183.3-1100



STEEL STAR
www.greatforming.com

Catalogo de producto

1. Máquina formadora de rollos de láminas de techo

1-4 Máquina formadora de rollos de láminas de techo de doble capa/modelos dobles

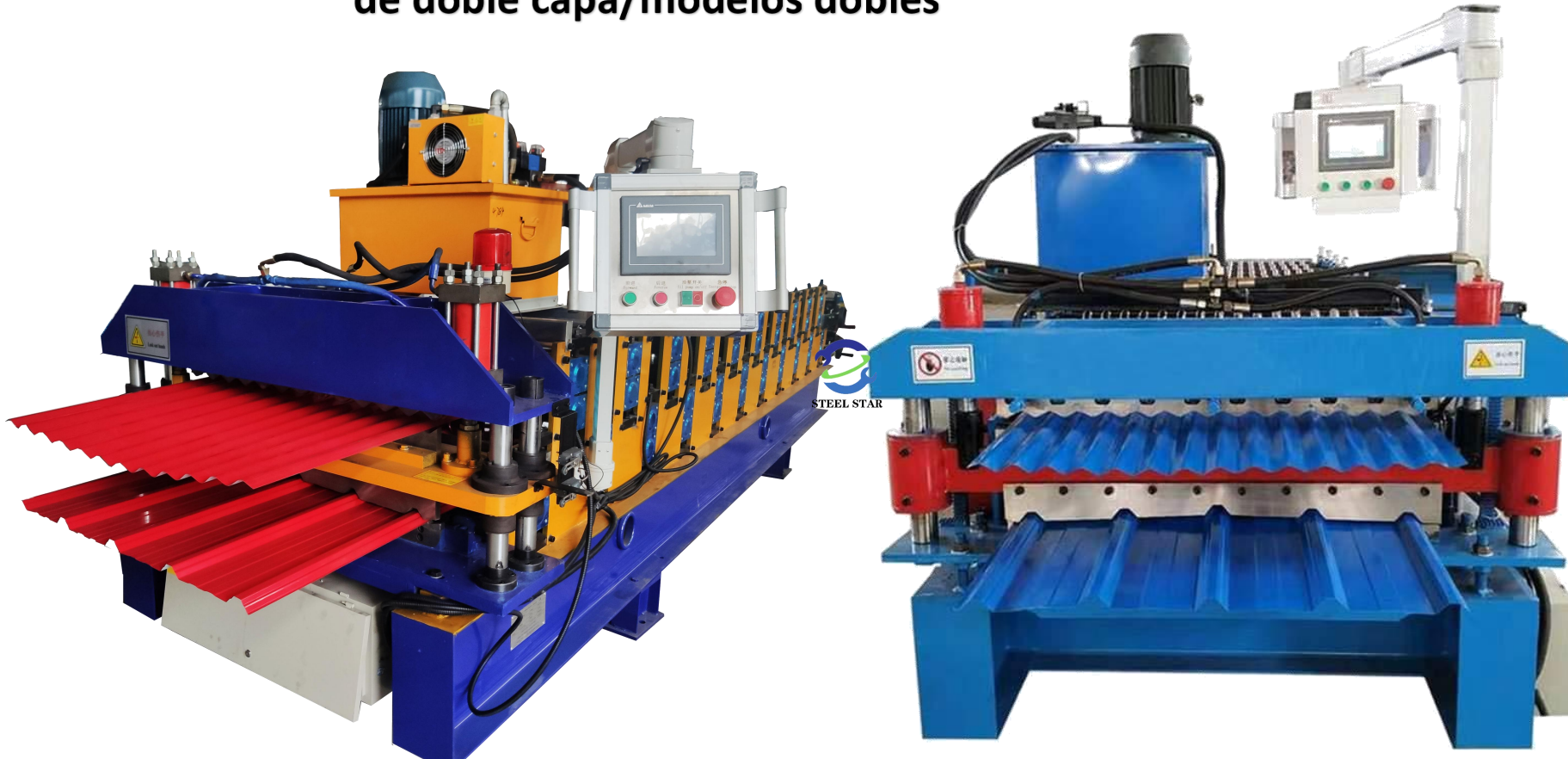

Escenarios de aplicación





STEEL STAR
www.greatforming.com

Catalogo de producto

1. Máquina formadora de rollos de láminas de techo

1-5 Máquina formadora de rollos de láminas de techo de tejas esmaltadas de doble capa/modelos dobles

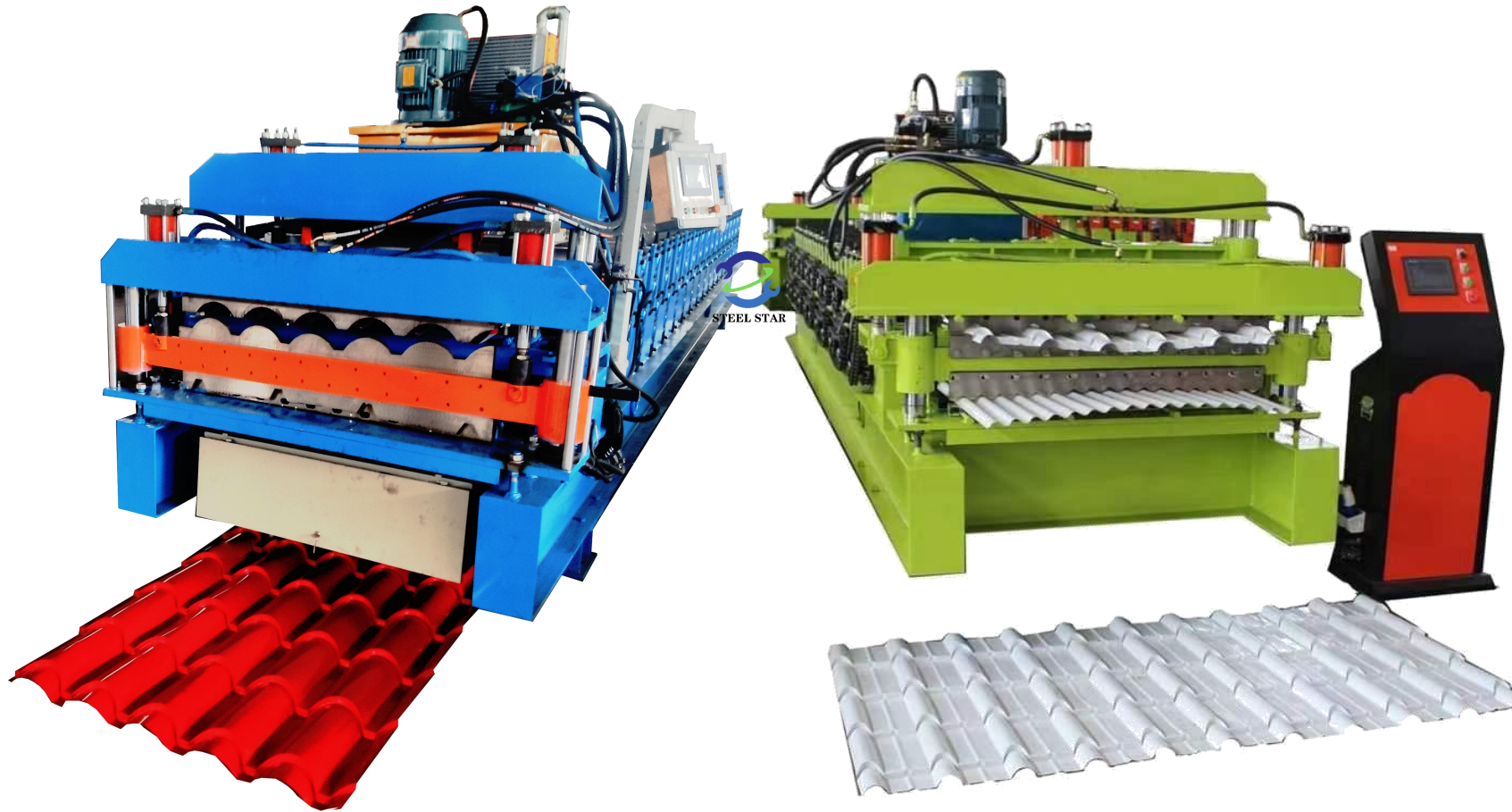

Application Scenarios





STEEL STAR
www.greatforming.com

Catalogo de producto

1. Máquina formadora de rollos de láminas de techo

1-6 Máquina formadora de rollos de láminas para techos de tres capas/tres modelos



Escenarios de aplicación





STEEL STAR
www.greatforming.com

Catalogo de producto

1. Máquina formadora de rollos de láminas de techo

1-7 Máquina arqueadora de láminas de techo completamente automática

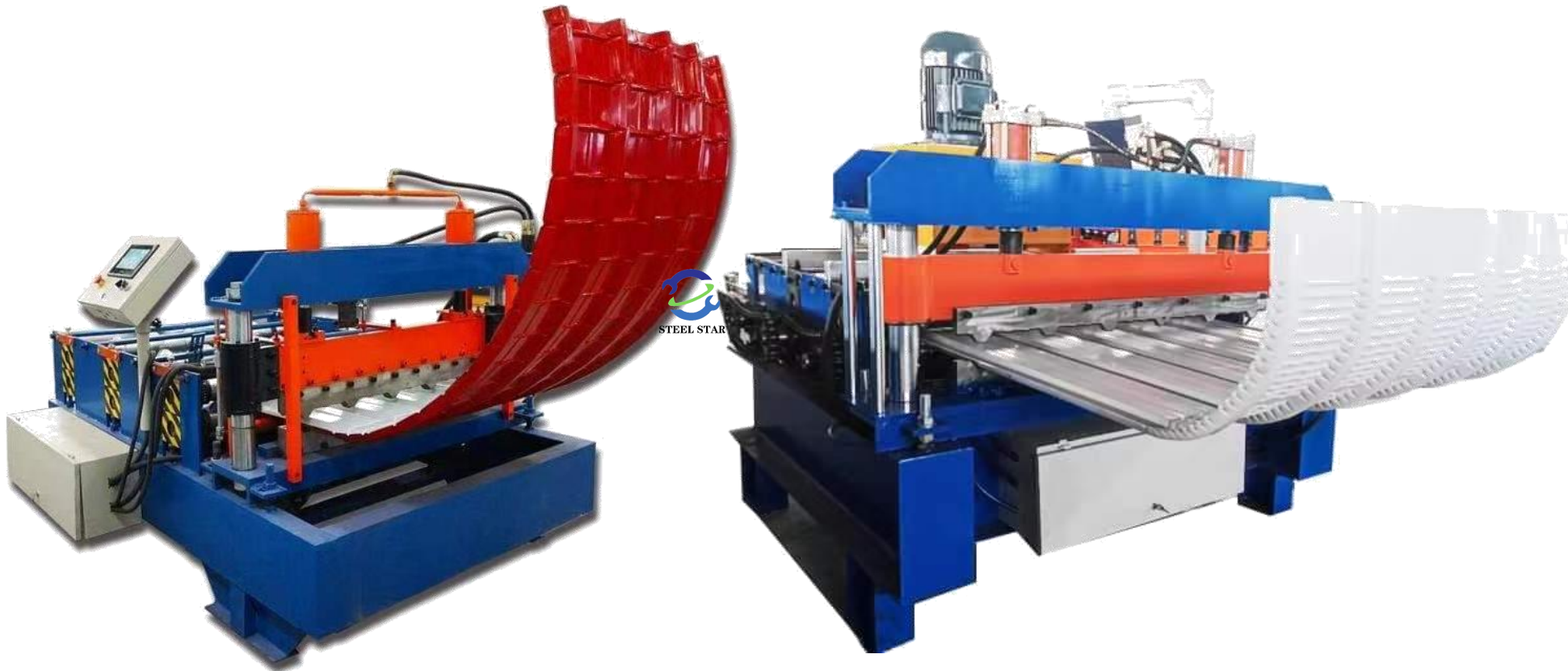

Escenarios de aplicación





STEEL STAR
www.greatforming.com

Catalogo de producto

2. Máquina formadora de rieles para pernos de quilla ligera

2-1 Máquina formadora de rollos de quilla y riel ligero C/U/V/Omega

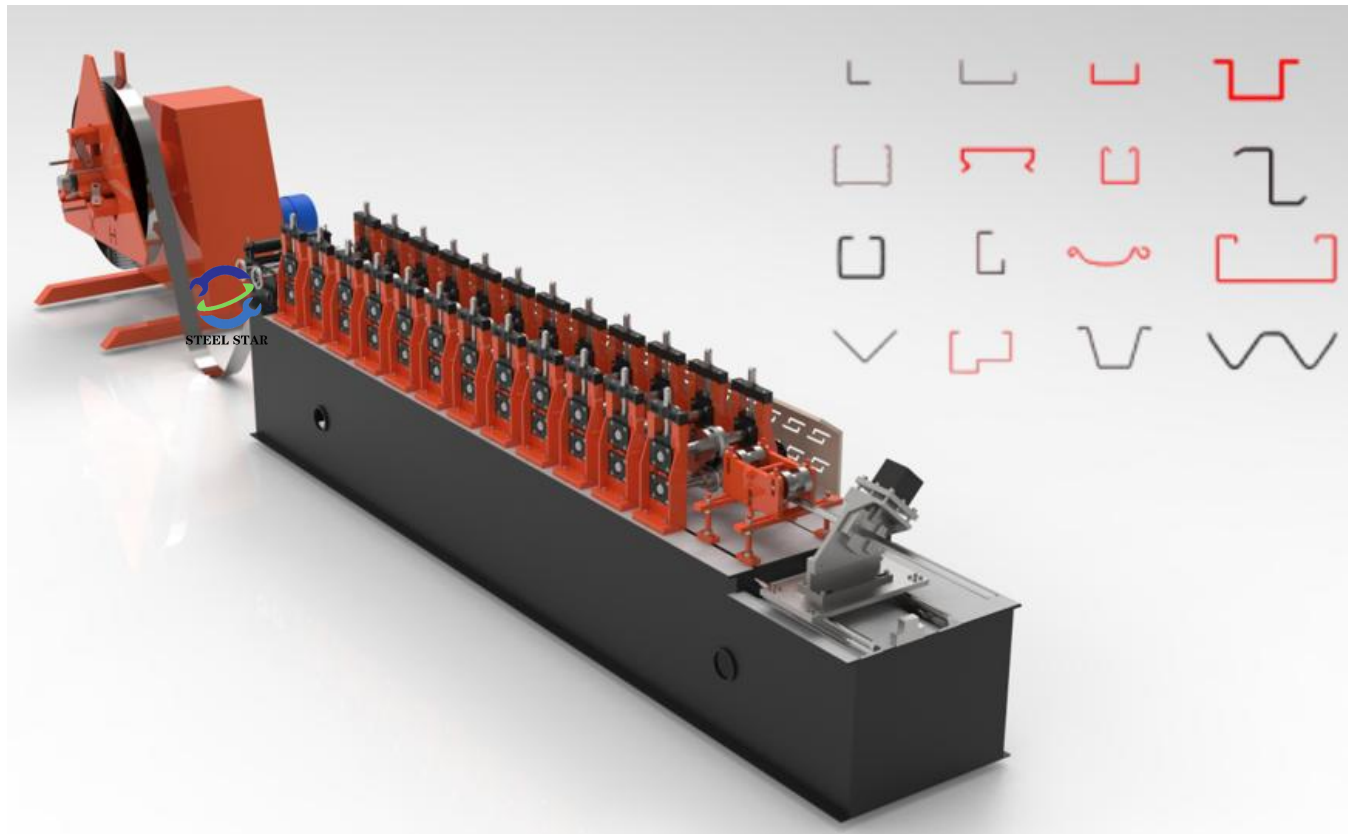

Alta velocidad

20 metros--150metros/minuto

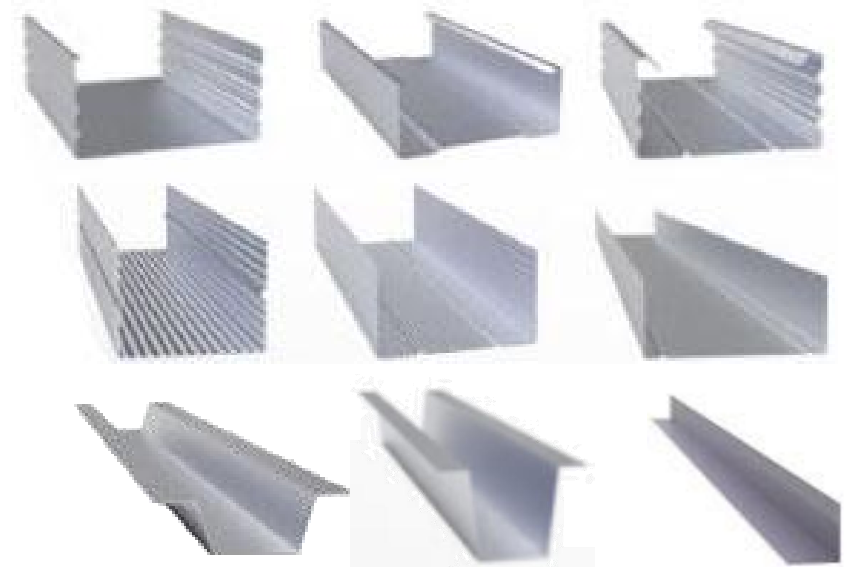



STEEL STAR
www.greatforming.com

Catalogo de producto

2. Máquina formadora de rieles para pernos de quilla ligera

2-1 Máquina formadora de rollos de quilla y riel ligero C/U/V/Omega

Escenarios de aplicación





Máquina formadora de rollos de quilla ligera de alta velocidad

STEEL STAR
www.greatforming.com

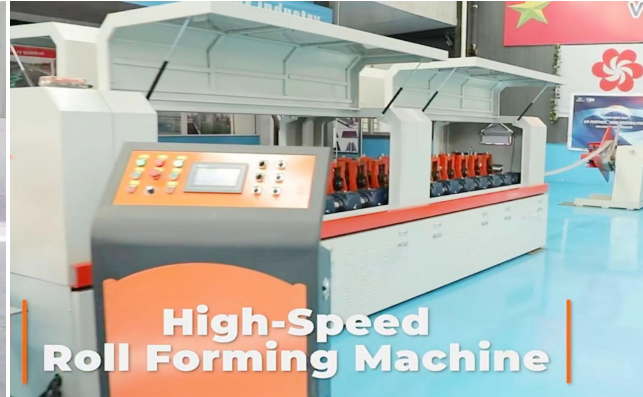

High-Speed Roll Forming Machine

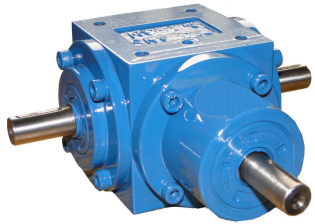

Estructura de la caja de cambios *Alta velocidad 50metros-150metros/minuto*



C--Modelo

U--Modelo

V--Modelo

Omega--Modelo

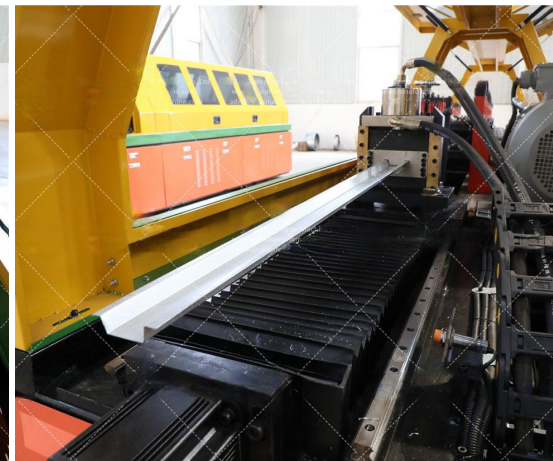
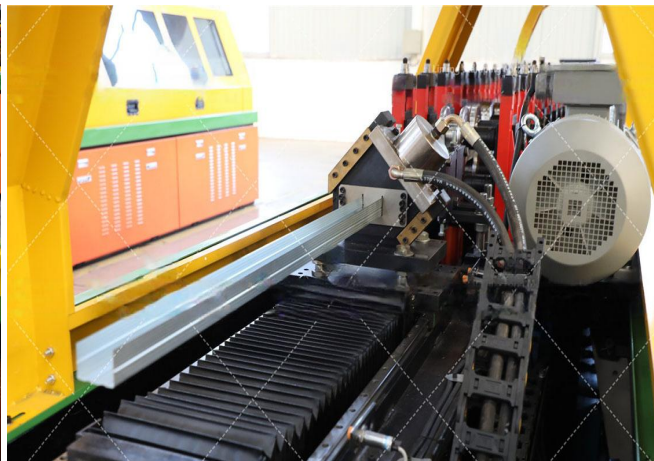



STEEL STAR
www.greatforming.com

Catalogo de producto

3. Máquina formadora de rollos de puerta de persiana

3-1 Máquina formadora de rollos de puerta de persiana

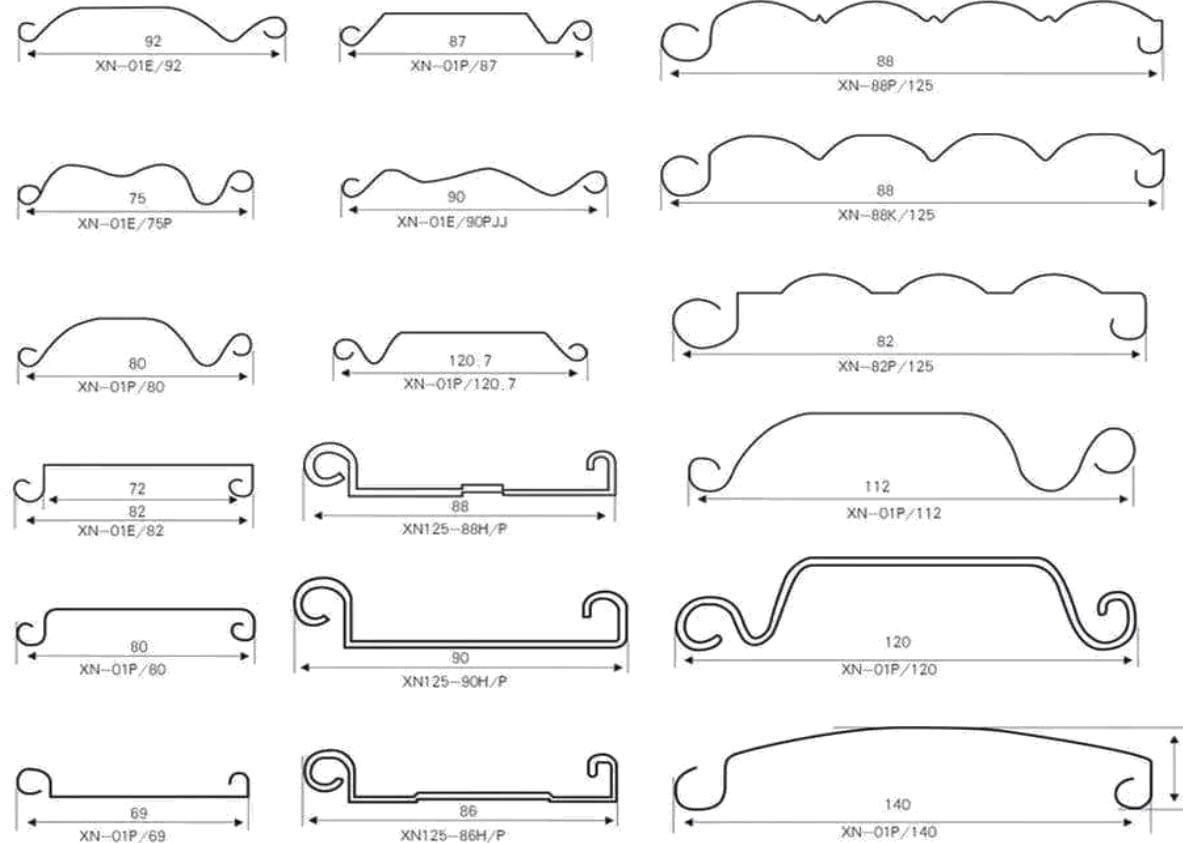
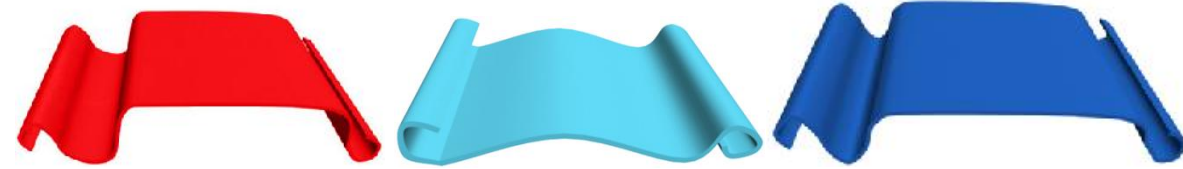
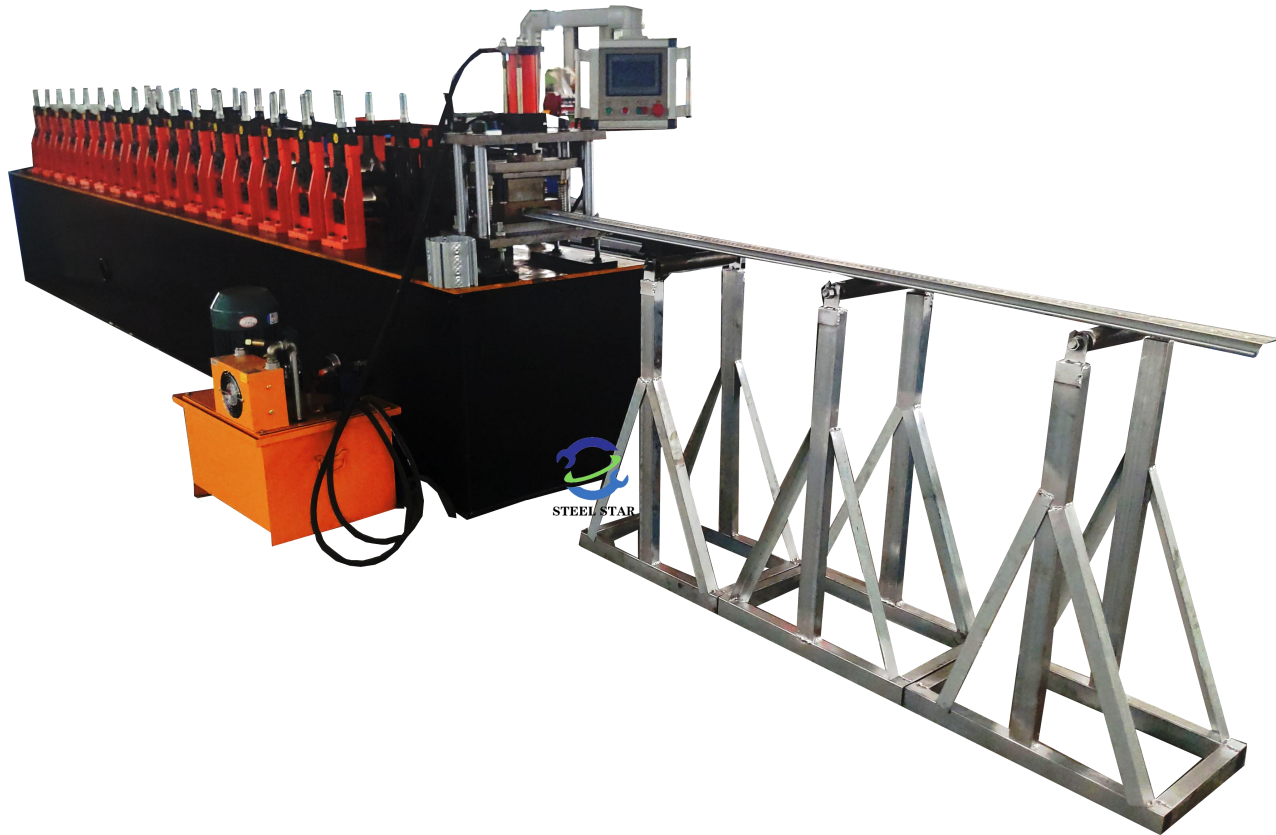



STEEL STAR
www.greatforming.com

Catalogo de producto

3. Máquina formadora de rollos de puerta de persiana

3-1 Máquina formadora de rollos de puerta de persiana

Escenarios de aplicación

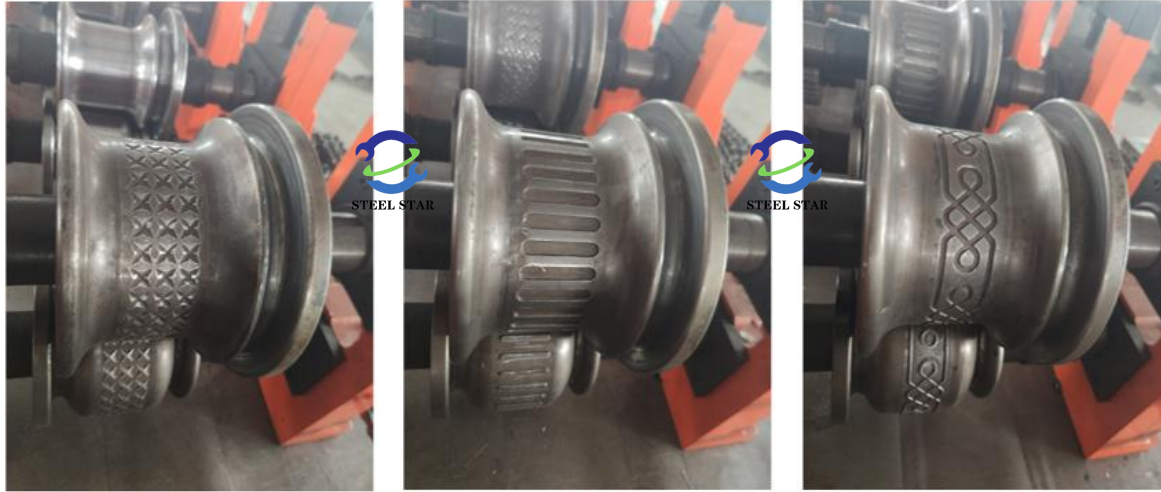



STEEL STAR
www.greatforming.com

Catalogo de producto

4. Máquina perfiladora de correas C/Z

4-1 Máquina perfiladora de correas C/Z

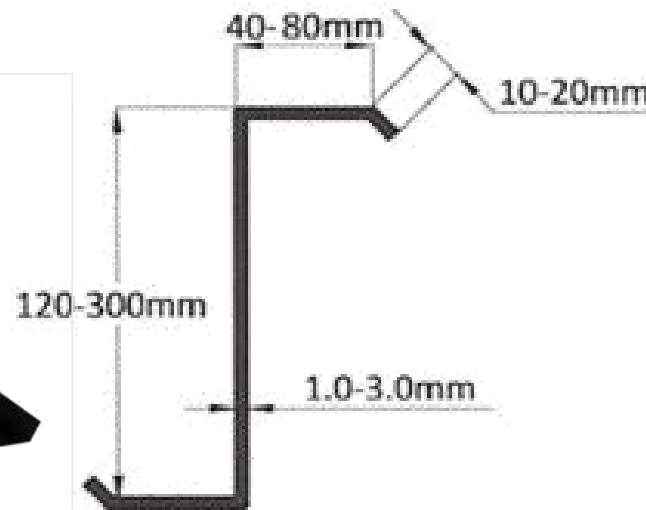
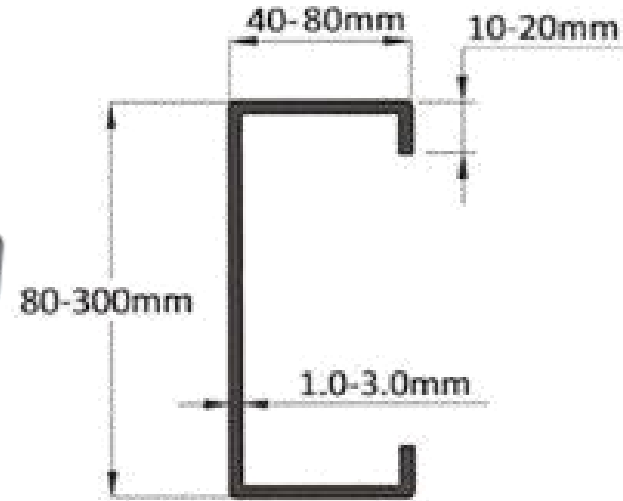
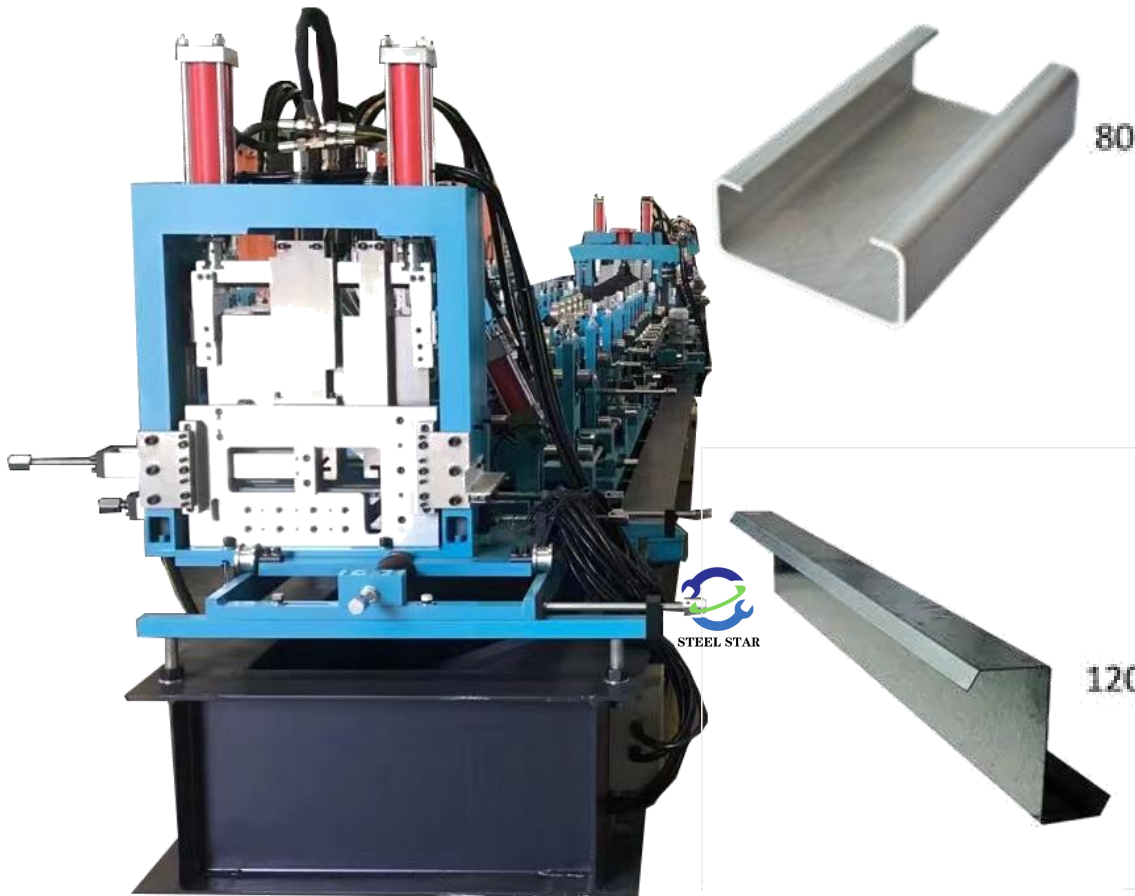

Escenarios de aplicación

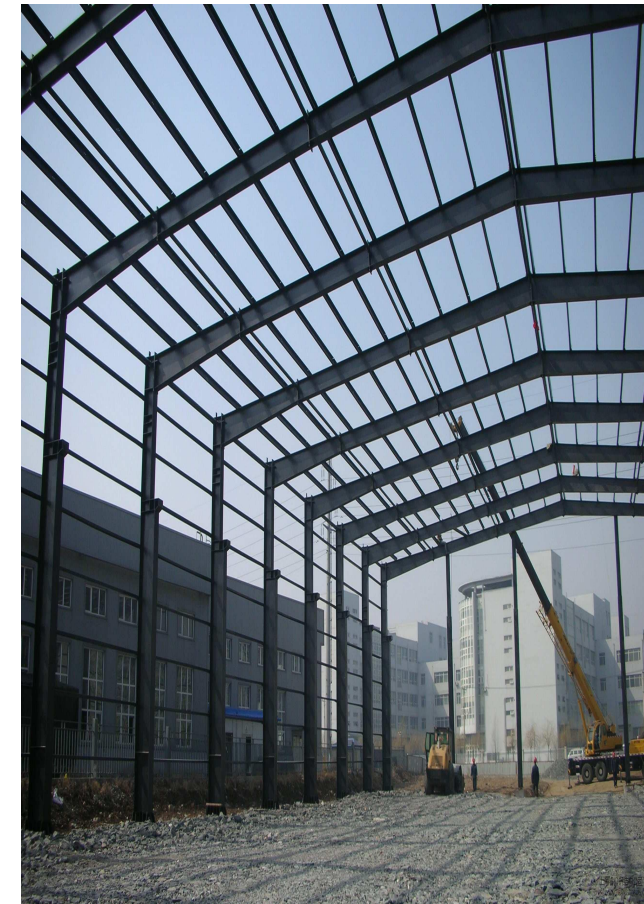



STEEL STAR
www.greatforming.com

Catalogo de producto

5. Máquina formadora de rollos de tapa de cresta

5-1 Máquina formadora de rollos de tapa de cresta



Escenarios de aplicación

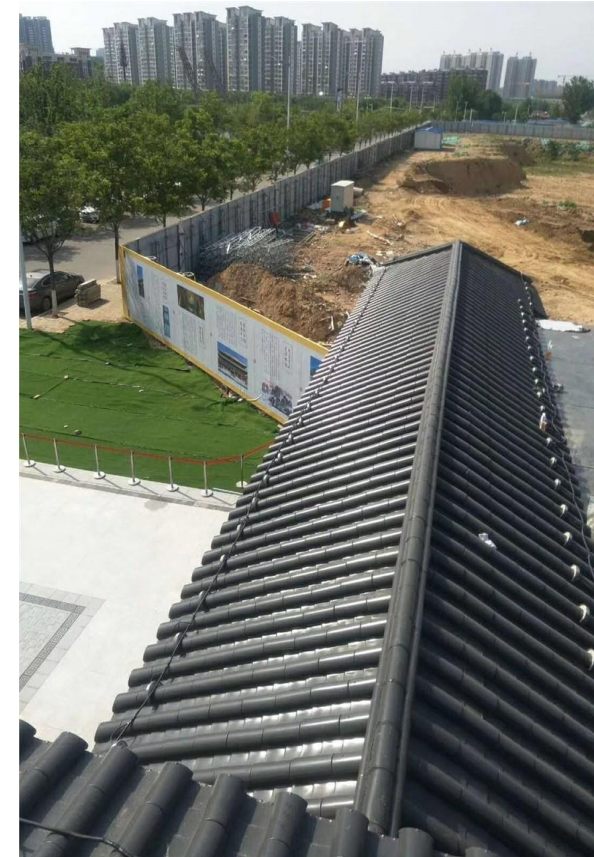



STEEL STAR
www.greatforming.com

Catalogo de producto

6. Máquina formadora de rollos corrugados de barril

6-1 Máquina formadora de rollos corrugados de barril

Escenarios de aplicación

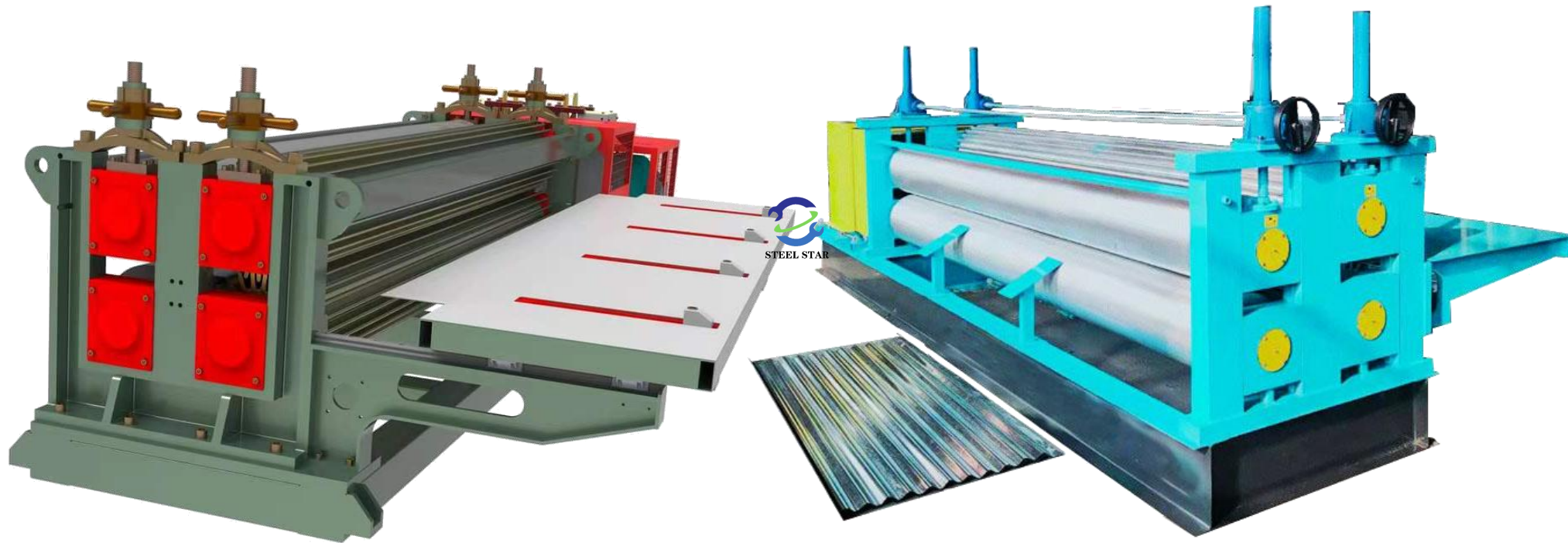



STEEL STAR
www.greatforming.com

Catalogo de producto

7. Máquina formadora de rollos de cubierta de piso

7-1 Máquina formadora de rollos de cubierta de piso

Escenarios de aplicación





STEEL STAR
www.greatforming.com

Catalogo de producto 8. Máquina perfiladora de tableros de automóviles

8-1 Máquina perfiladora de tableros de automóviles

Escenarios de aplicación

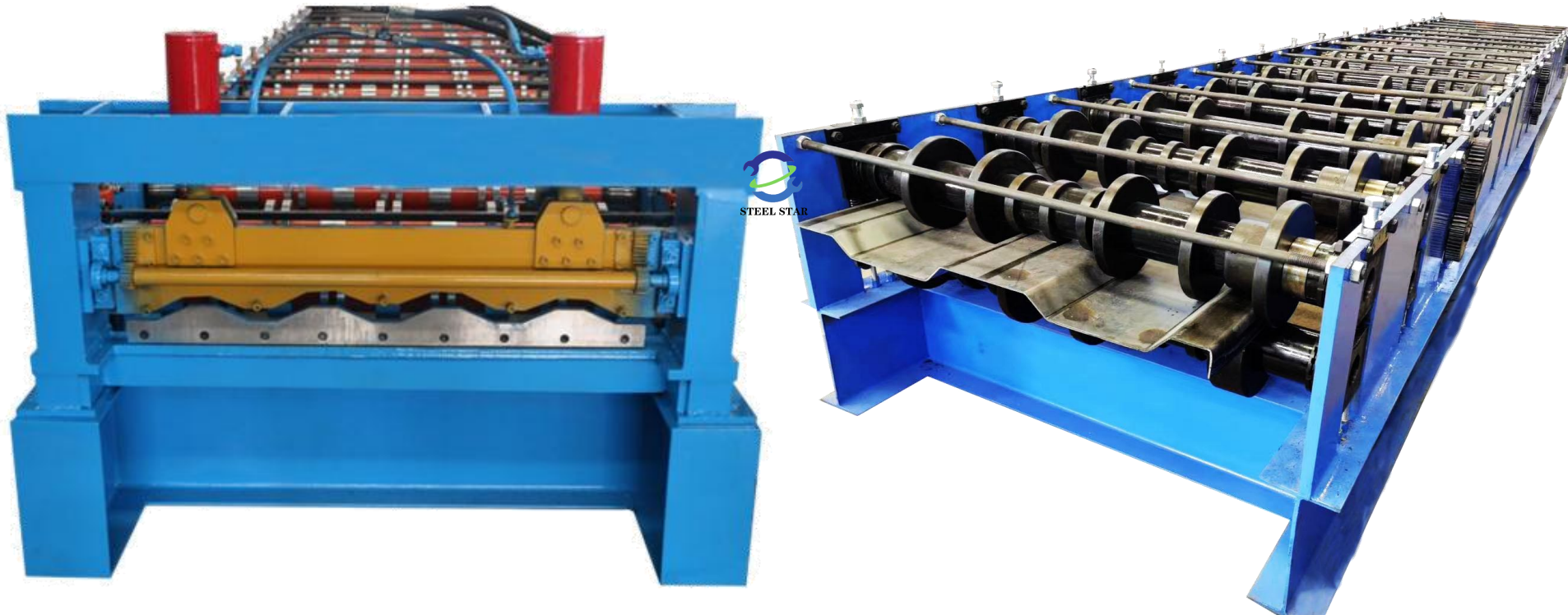



STEEL STAR
www.greatforming.com

Catalogo de producto 9. Máquina perfiladora de canalones de lluvia/bajantes de lluvia/bajantes

9-1 Máquina perfiladora de canalones de lluvia/bajantes

Escenarios de aplicación

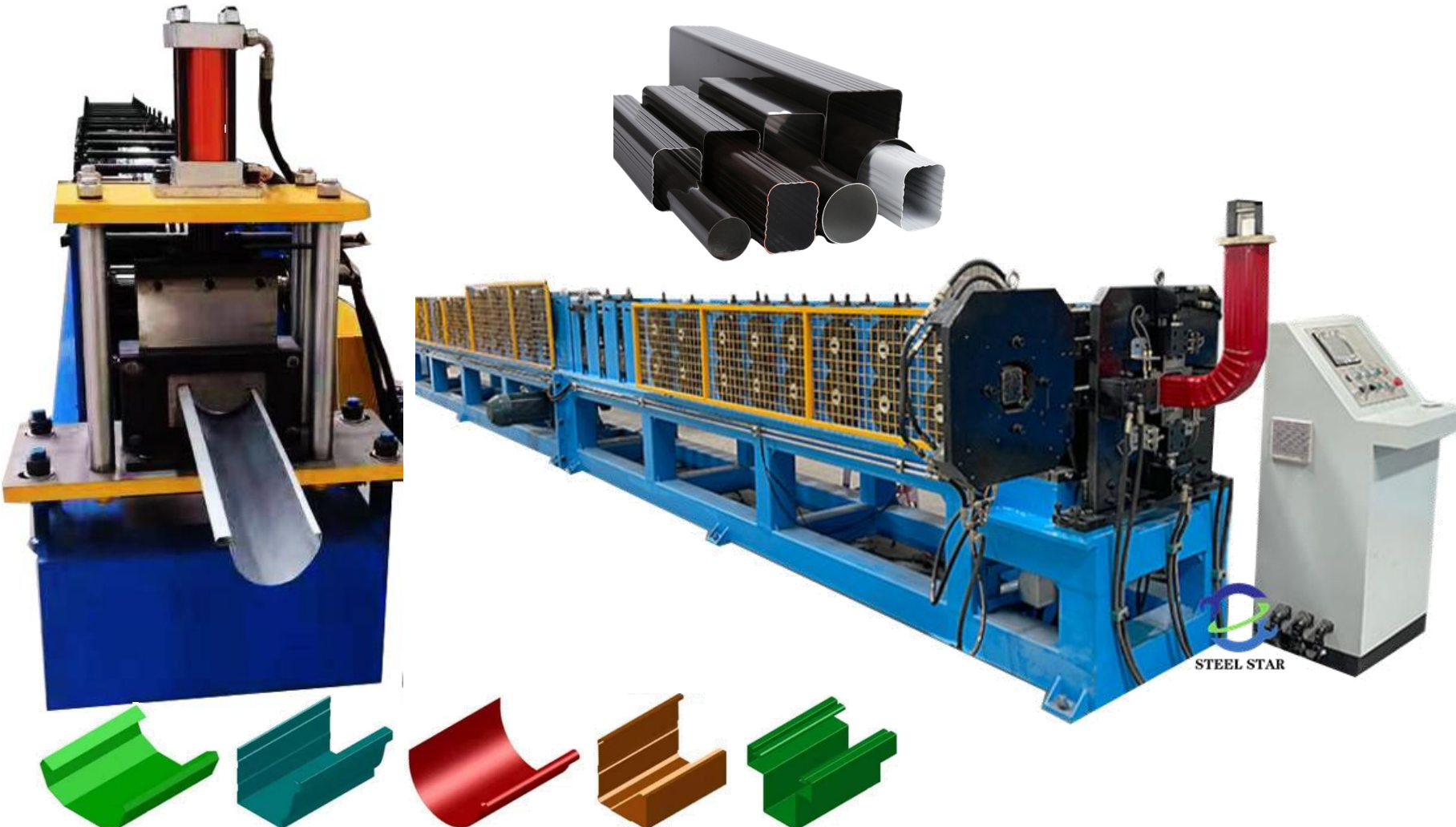



STEEL STAR
www.greatforming.com

Catalogo de producto

10. Máquina formadora de rollos de marco de villa de quilla ligera

10-1 Máquina formadora de rollos de marco de villa de quilla ligera

Escenarios de aplicación

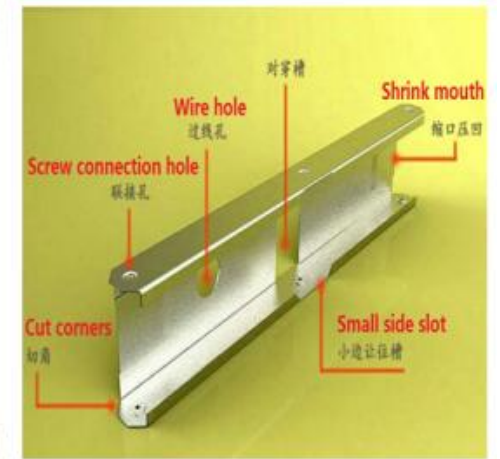
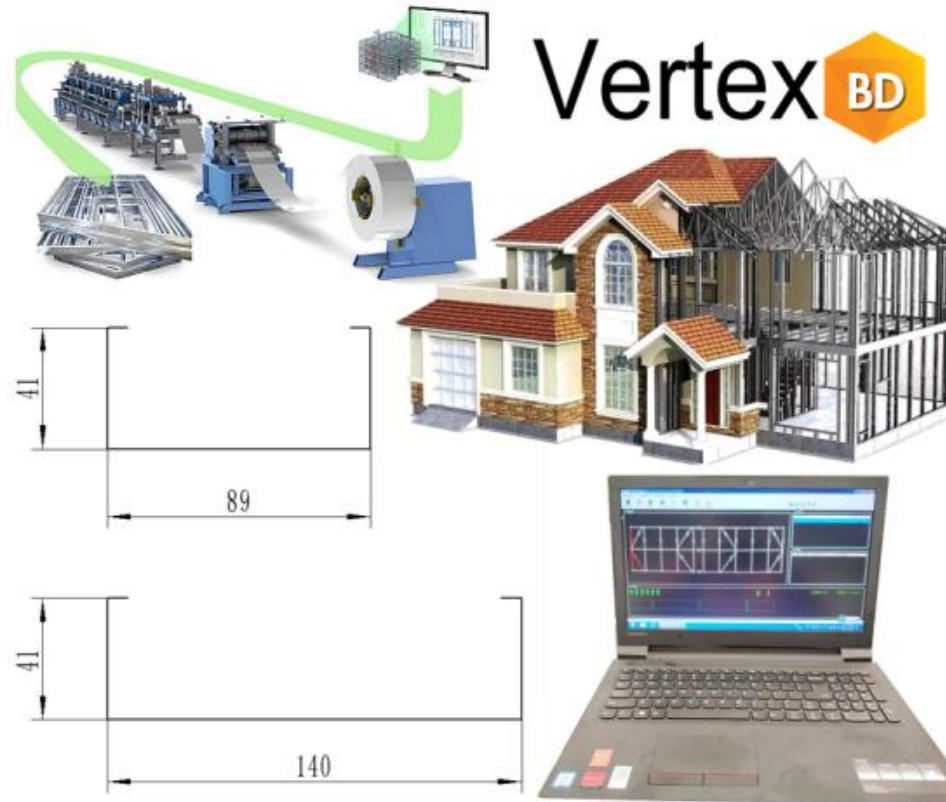



STEEL STAR
www.greatforming.com

Catalogo de producto 11. Máquina perfiladora de placas de barandilla de placa

11-1 Máquina perfiladora de placas de barandilla

Escenarios de aplicación

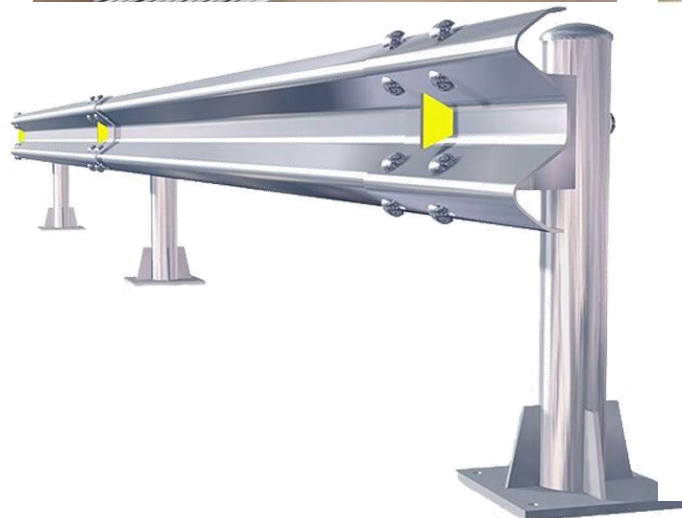
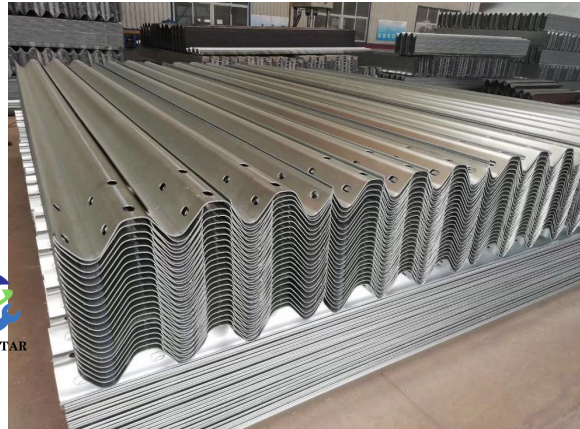



STEEL STAR
www.greatforming.com

Catalogo de producto

12. Línea de producción de compuestos de láminas para techos de espuma/lana de roca

12-1 Línea de producción de compuestos de láminas para techos de espuma/lana de roca

Escenarios de aplicación

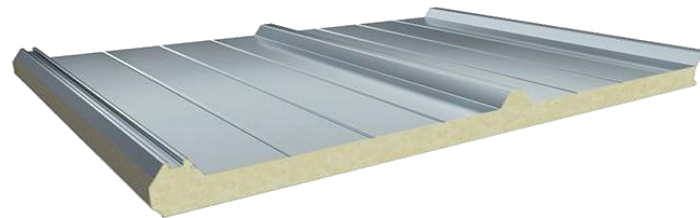
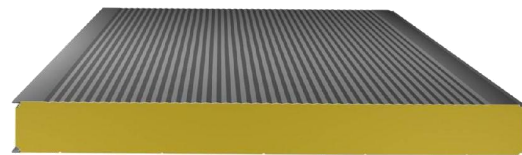
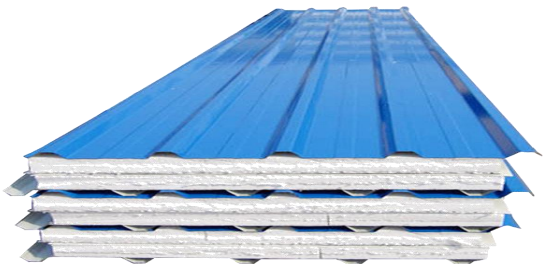



STEEL STAR
www.greatforming.com

Catalogo de producto 13. Máquina desbobinadora/apiladora automática deláminas para paneles de techo

13-1 Máquina desbobinadora/apiladora automática deláminas para paneles de techo

Escenarios de aplicación

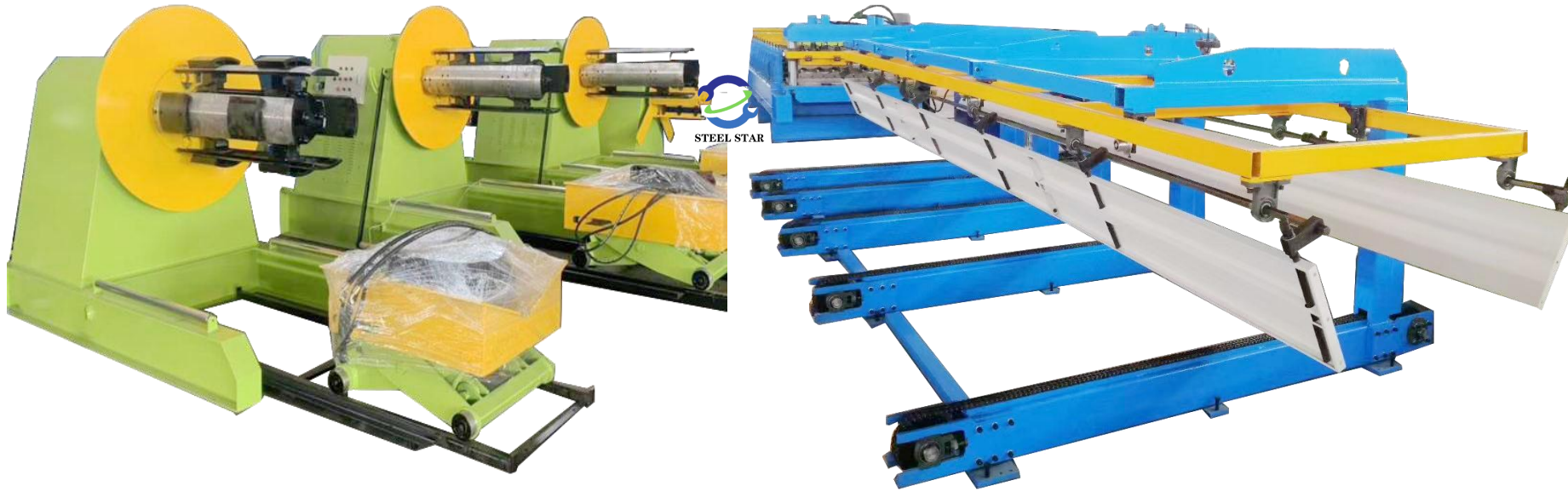



STEEL STAR
www.greatforming.com

Catalogo de producto

14. Máquina dobladora / Cizalla guillotina

14-1 Máquina dobladora / Cizalla guillotina

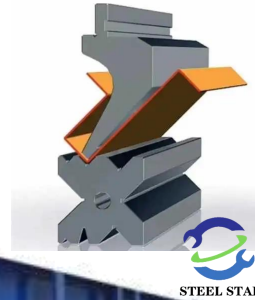
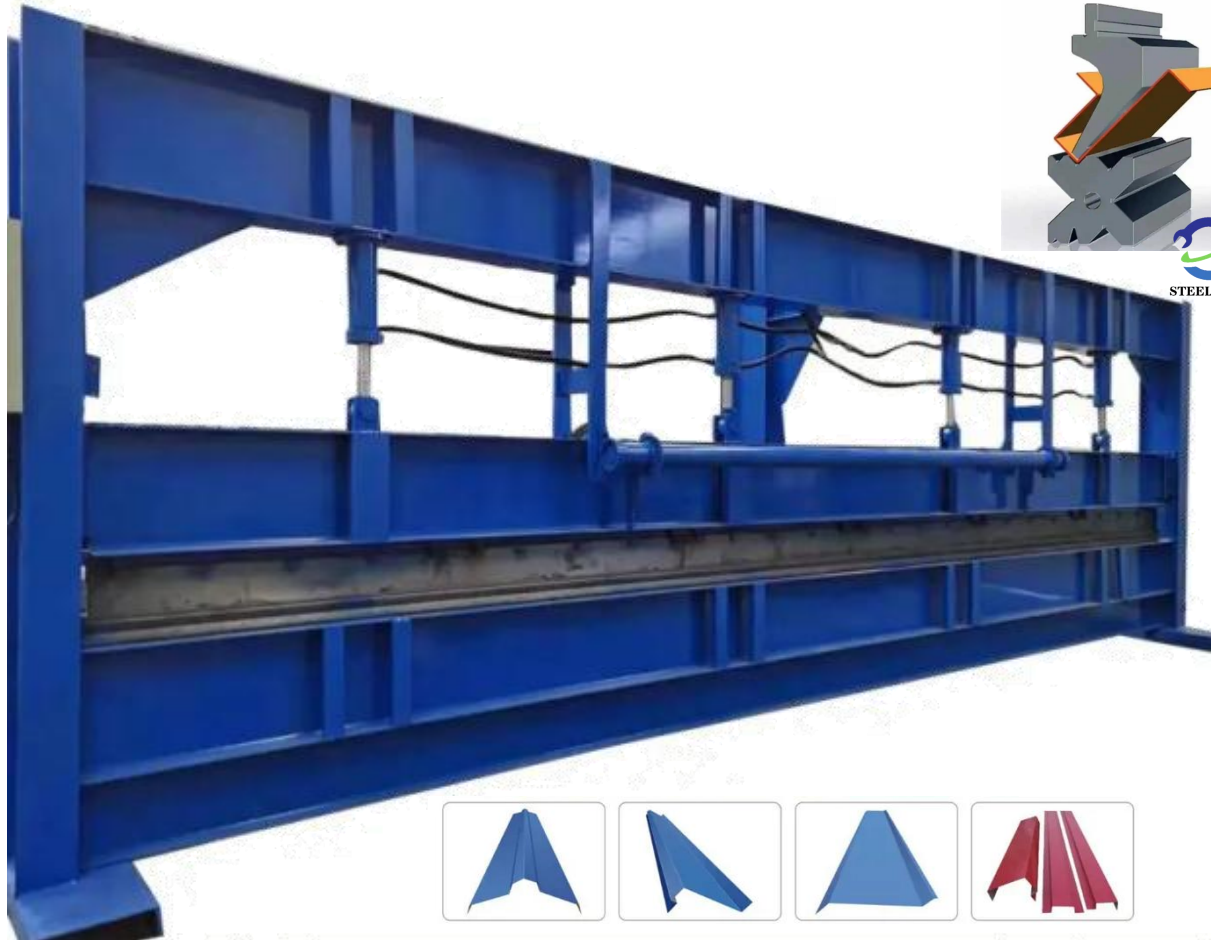

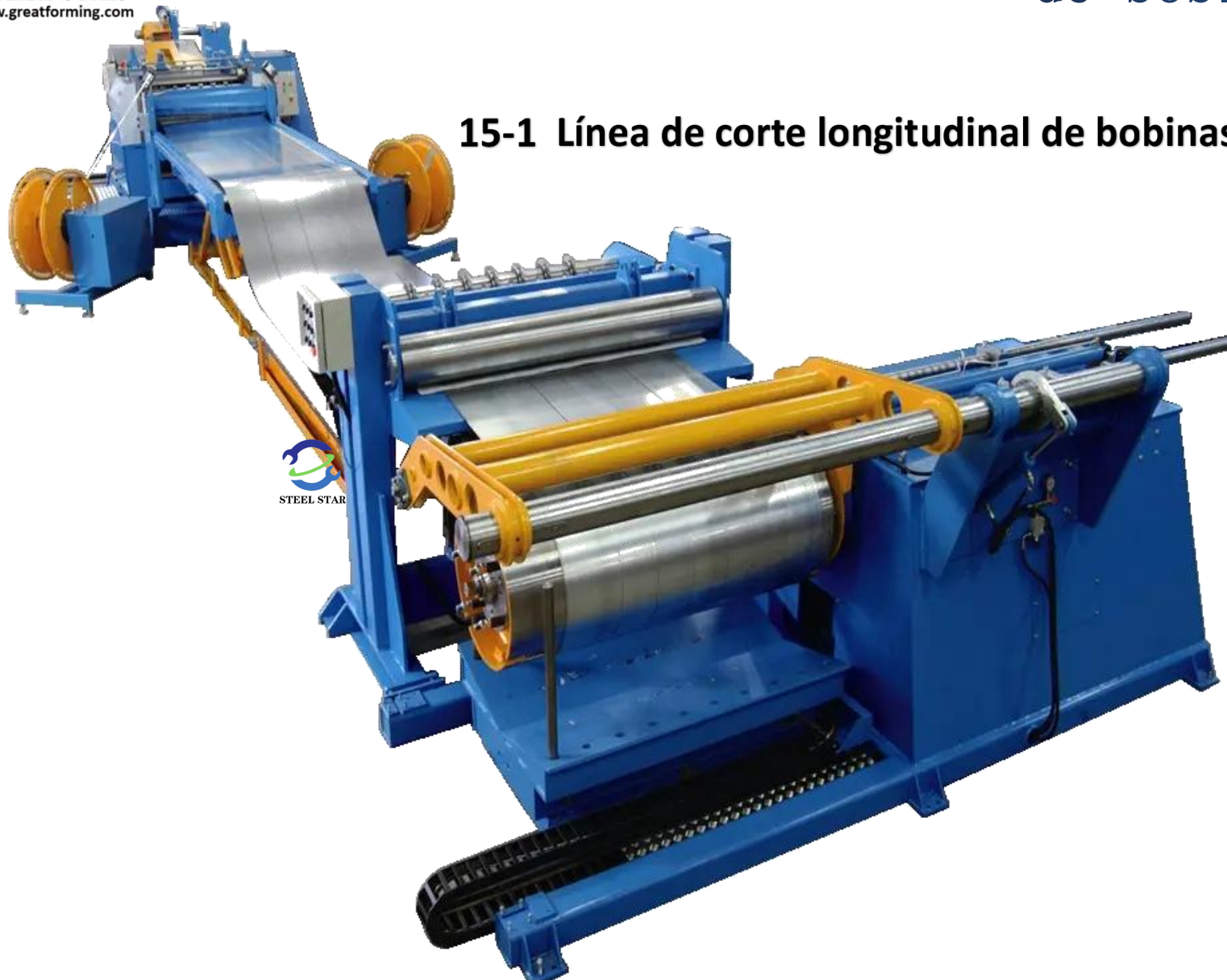

15-1 Línea de corte longitudinal de bobinas de acero

Escenarios de aplicación

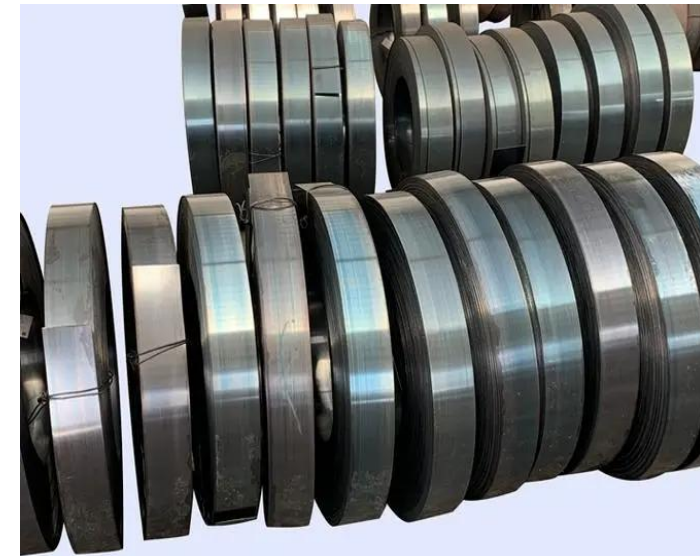
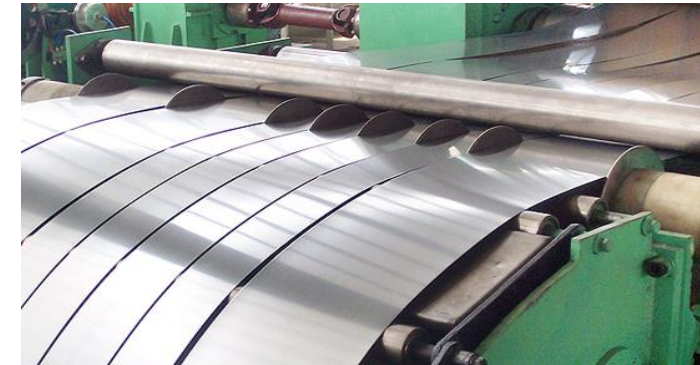



STEEL STAR
www.greatforming.com

Catalogo de producto

16. Máquina de soporte solar

16-1 Máquina de soporte solar



Escenarios de aplicación





STEEL STAR
www.greatforming.com

Catalogo de producto

17. Máquina para fabricar tubos de acero

17-1 Máquina para fabricar tubos de acero



Escenarios de aplicación

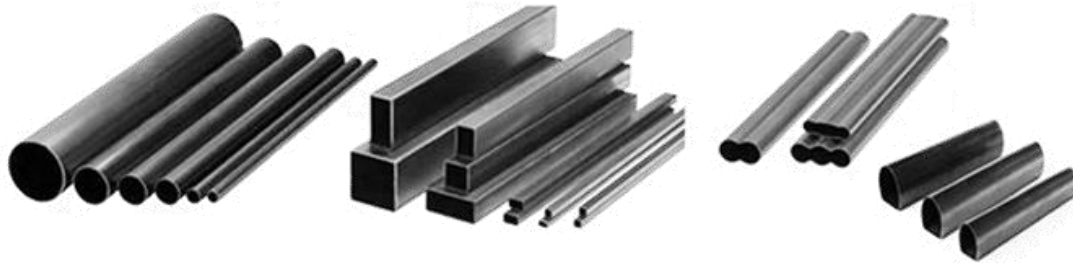



STEEL STAR
www.greatforming.com

Catalogo de producto

18. Se pueden personalizar varios productos

18-1 Se pueden personalizar varios productos

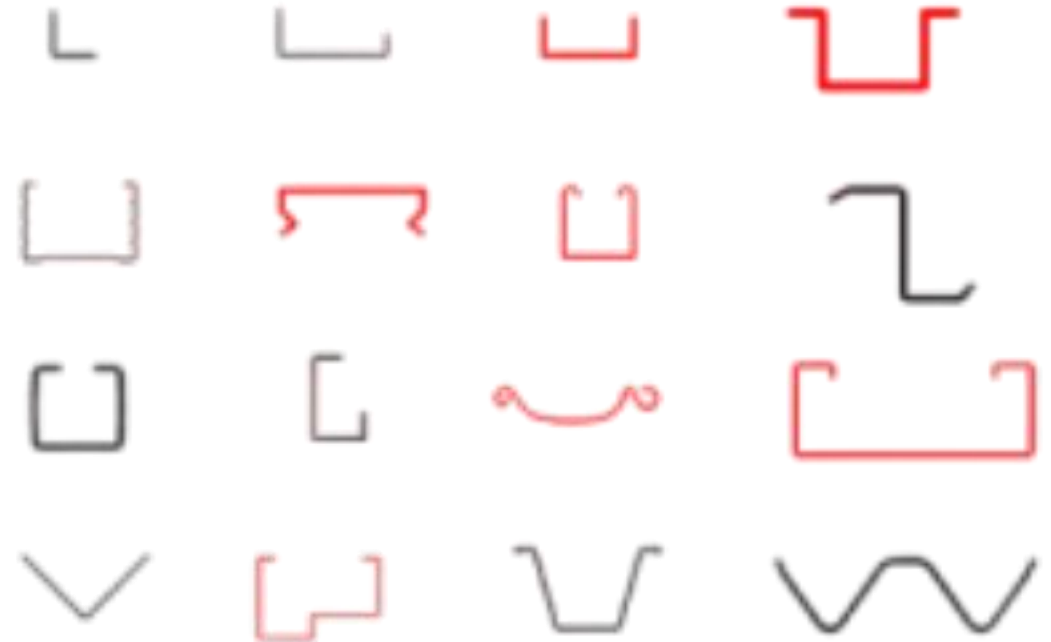



STEEL STAR
www.greatforming.com

Envío al extranjero





STEEL STAR
www.greatforming.com

Servicio



Nuestro servicio de atención al cliente le ayudará a solucionar cualquier problema relacionado con el sistema: nuestro servicio está disponible las 24 horas del día durante los días laborables. Responderemos a tus preguntas de forma rápida y fiable.

Si es necesario, enviaremos personal profesional de equipos de instalación y depuración que pueda ir a su ciudad y ayudarlo a instalar el equipo en el sitio.





STEEL STAR
www.greatforming.com

Contacta con nosotros

Página web oficial : www.greatforming.com

Correo electrónico(Email) : sam@greatforming.com





+86 15075780050



WhatsApp Wechat



China



Beijing		1 Hour	
		4 Hour	

Tianjin		0.5 Hour	
		2.5 Hour	

Jinan		1 Hour	
		3 Hour	